

Apollo

AP1421

Single Bowl Sink With Drainer

All dimensions in mm

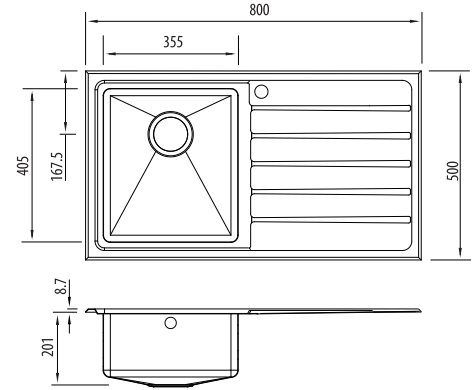

Specifications /

Sink size	800W x 500H mm
Bowl size	Main Bowl 355W x 405H x 200D / 29L
Construction	Fabricated with 18 mm radius corners, Softtone® and soundproofing.
Material	304 grade, 18/10 brushed stainless steel (1.2 mm thick)
Installation	Topmount
Fixings	Topmount clips supplied
Min cabinet size	500 mm
Tap holes	1 tap hole only
Waste fittings	1 x 90 mm basket waste included
Overflow	Not available
Carton size	855 x 575 x 270 mm
Weight	13 kg
Warranty	Lifetime manufacturer's warranty (refer to oliveri.com.au)
Maintenance and care instructions	All surfaces should be cleaned with mild liquid detergent or soap and water. To maintain the shine on your Oliveri stainless steel sink, we recommended the use of any of the easy to obtain, non-abrasive stainless steel cleaners or metal polishes.

Included accessories /

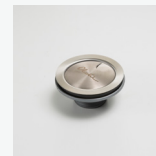

AC28
Basket Waste



ACP134
Colander

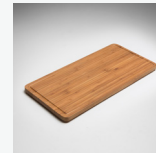

ACP124
Bamboo Board